

# BUNKALITE EMERGENCY LUMINAIRE









## Robust and Weatherproof LED Circular

The Bunkalite is an IP65 and IK10 luminaire that is ideal for outdoor covered applications such as corridors, stairwells and walkways in schools and apartment blocks. Constructed with a powder-coated steel body and white opal polycarbonate diffuser the Bunkalite provides a decorative solution for both industrial and commercial use.

Market leading lithium battery technology provides lower maintenance costs and LED lamps provide a low standby power rating that will reduce energy costs significantly.

Available in White, Black, Grey and Silver options to suit various environments.

### Applications

- |   |   |
|---|---|
|  Apartments |  Car Parks         |
|  Factories  |  Public Amenities  |
|  Schools    |  Sports Facilities |



### Features and Benefits

- Tested to BS EN 60598-2-22
- IP65 Weatherproof
- IK10 Impact rating
- LED lamps
- Power Coated steel body
- Available in Black, White, Grey and Silver
- Lithium Iron Phosphate battery
- Microwave sensor option
- DALI® and Zoneworks® test options available
- Clevertest Plus System compatible



# BUNKALITE EMERGENCY LUMINAIRE

ORDERING INFORMATION		CLP	MAINS
TEST OPTIONS   PART NO	Standard - White	CBKLEDS-WHT	FBKLED-WHT
	Standard - Black	CBKLEDS-BLK	FBKLED-BLK
	Clevertest Plus System compatible	Yes	-
	DALI	CBKLEDS-DALI-WHT	-
	Zoneworks® XT Hive	CBKLEDS-HVG-WHT	-
	Motion Sensor	Yes	-
Carton Quantity	1		
Weight - single (carton)	4.5kg		
Dimensions (D x H)	360mm x 145mm		

POWER, LAMPS AND BATTERY	CLP	MAINS
Power Consumption (Standby / Max)	1.2W / 21W	16W
Lamp(s)	LED Module 4000K / 50,000hrs	
Total Lumen Output	1945lm	1945lm
Battery	Lithium Iron Phosphate	-
Voltage / Capacity (mAh)	3.2V / 6400mAh	-
Charging Method	Intelligent Current Limited Constant Voltage	-

TECHNICAL SPECIFICATIONS	CLP	MAINS
Operating Mode	Sustained	Non-Emergency
Voltage (V) (Frequency (Hz))	220-240V (50Hz)	
Operating Temperature	0°C to 40°C	
Ingress Protection Rating (IP)	IP65	
Impact Rating (IK)	IK10	

LUMINAIRE CLASSIFICATION	CLP			
Without Automatic Testing	X	2	AG	180
With Automatic Testing	X	2	AFG	180

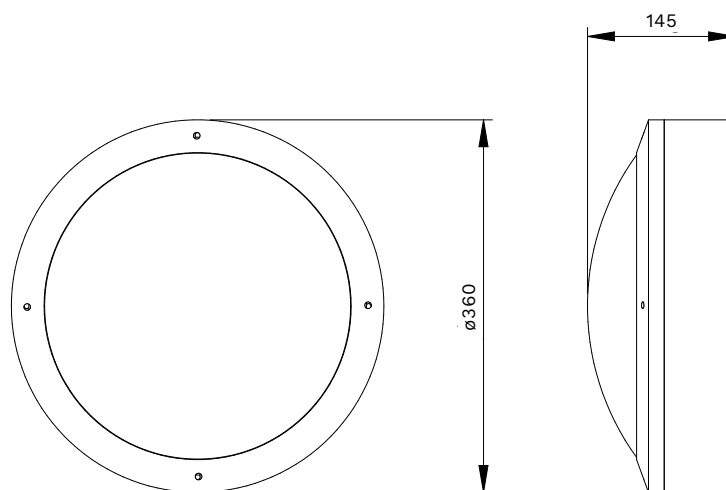

Dimensions (mm)

\*Warranty information located at: <https://clevertronics.co.uk/product-warranty-statement/>

The product details described in this document are current as at the version date of the document. We reserve the right to change product design, specifications or materials (Specifications) as part of our continuous improvement program. Please confirm the applicable Specifications at the time of placing your order.

**clevertronics.co.uk**

362 Stockley Close, West Drayton, London UB7 9BL

Clevertronics International UK Ltd trading as Clevertronics, with registered number 11249539, whose registered office is at 843 Finchley Road London NW11 8NA. 248UK UK Catalogue 2021

