

BUNKALITE









Robust & Weatherproof LED Circular

The Bunkalite is an IP65 rated emergency luminaire that is ideal for outdoor covered applications such as corridors, stairwells and walkways in schools and apartment blocks.

Market leading lithium battery technology provides lower maintenance costs and LED lamps provide a low standby power rating that will reduce energy costs significantly.

Constructed with a powder coated steel body and white opal polycarbonate diffuser the Bunkalite provides a decorative solution for both industrial and commercial use.

Applications

- | | |
|---|---|
|  Apartments |  Car Parks |
|  Factories |  Public Amenities |
|  Schools |  Sports Facilities |



Features and Benefits

- AS/NZS 2293.3 compliant
- IP65
- IK10
- LED lamps
- Powder coated steel body
- Available in black, white, grey and silver
- Lithium Iron Phosphate battery
- Clevertest Plus System compatible
- Microwave sensor option



BUNKALITE

ORDERING INFORMATION		LP	240V
TEST OPTIONS / PART #	Standard - White	CBKLEDS-WHT	FBKLED-WHT
	Standard - Black	CBKLEDS-BLK	FBKLED-BLK
	Clevertest Plus System Compatible	Yes	-
	DALI	CBKLEDS-DALI-WHT	-
	Zoneworks® XT Hive	CBKLEDS-HV-WHT	-
	Motion Sensor	Yes	Yes
Carton Quantity	1		
Weight - Single (Carton)	4.5kg		
Dimensions (D x H)	360mm x 145mm		

POWER, LAMPS AND BATTERY	LP	240V
Power Consumption (Standby / Max)	1.0W / 20.3W	16W
Lamp(s)	LED Module 4000K / 50,000hrs (L70 / E50 Ta40)	
Total Lumen Output	1945lm	1945lm
Battery	Lithium Iron Phosphate	-
Voltage / Capacity (mAh)	3.2V / 3200mAh	-
Charging Method	Intelligent Current Limited Constant Voltage	-

TECHNICAL SPECIFICATIONS	LP	240V	CLASSIFICATION	LP
	Operating Mode	Sustained		Non-Emergency
Voltage (V) (Frequency (Hz))	220-240V (50Hz)		C90	D32
Operating Temperature	0°C to 40°C			
Ingress Protection Rating (IP)	IP65			
Impact Rating (IK)	IK10			

SPACING TABLE AND MOUNTING HEIGHTS – AS/NZS 2293.1:2018 (MINIMUM LIGHT LEVEL OF 0.2 LUX)														
Classification	2.1m	2.4m	2.7m	3.0m	3.3m	3.6m	4.0m	4.5m	5.0m	6.0m	7.0m	8.0m	9.0m	10.0m
D32	11.5	13.2	14.8	16.5	17.6	18.0	18.5	19.0	19.5	20.1	20.5	20.7	20.6	20.3

For 1 lux and AS/NZS 2293.1:2005 spacing tables please visit:
<https://clevertronics.com.au/spacing-tables/>

*Warranty information located at:
<https://clevertronics.com.au/warranty-statement/>

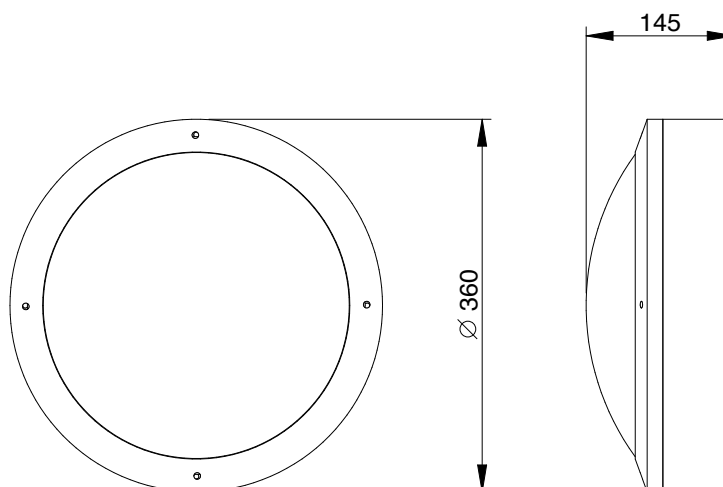

Dimensions (mm)

clevertronics.co.nz
clevertronics.com.au

1 Caribbean Drive, Scoresby VIC 3179
 P +61 3 9559 2700 F +61 3 9559 2799 E info@clevertronics.com.au

Clevertronics is committed to continuously improving its products.
 All features and specifications are subject to change without prior notice.
 _PRODUCT SHEETS – ANZ Bunkalite 04OCT22

