



Zoneworks, HIVE and DATA Monitored Options

Fittings with part numbers -ZW, -HVG, -DATA are fitted with Zoneworks communications modules (nodes). These fittings are monitored using either Powerline Carrier Technology that utilize the power cable to provide data communication, RF transceiver modules operating in the ISM band or a dedicated data cable to/from data routers installed on a dedicated data trunk connected to a central Server (can also be connected via Ethernet/Internet/Fibre). Zoneworks software on the server is used to monitor, coordinate testing and collate test data from each fitting. Zoneworks Fittings can be commissioned by a single push of the test switch or by scanning the supplied barcode. The LED Test Switch indicator provides a multifunction indication of the status of the fitting during testing and normal operation:

Option	State	LED Operation
ZW, HVG, DATA	Commissioned	LED on Solid (Green)
ZW, DATA	Un-commissioned	Batt plugged-in: yellow 1s, green 1s
		Batt unplugged: red 1s, off 1s
HVG	Un-commissioned With network connectivity	Batt plugged-in: yellow 1s, green 1s
		Batt unplugged: red 1s, off 1s
HVG	Un-commissioned Without network connectivity	Batt plugged-in: yellow 250mS, green 250mS, yellow 250mS, green 250mS, green 1s
		Batt unplugged: red 250mS, off 250mS, red 250mS, off 250mS, off 1s
ZW, DATA	Emergency Light Test In Progress	LED flashes at yellow 5s , Off 1s
HVG	Emergency Light Test In Progress	LED flashes at yellow 1s , Off 1s

In the case of the DATA version a 2-way "figure 8" cable and terminal block facilitates the connection to the DATA network via a multi-drop bus (daisy chain connection). For further information of installation of a Zoneworks system, please refer to the Zoneworks Users Guide and Commissioning Guide (incl. DATA version)

DALI 2 EM Option

Luminaires with part numbers having -D2 are fitted with DALI 2 certified modules (nodes) that facilitate connection and integration to 3rd Party Lighting Control Systems. Before installing the fitting please confirm that the Lighting Control System has the capability to monitor DALI Emergency Luminaires. The fitting will be addressed and configured into the control system by the Lighting Control System Commissioning Technicians and not Clevertronics

State	LED Operation
Commissioned/ Un-commissioned	LED on Solid (Green)
Emergency Light Test in progress	LED flashes at 1s On (Yellow) & 1s Off
"IDENTIFY COMMAND"	Lamp and Status LED Flash for 30 seconds

A 2-way "figure 8" cable and terminal block facilitates the connection to the DALI network OR a 5/6way "structured wiring system" lead and plug facilitating the power and DALI connection. DALI connections are marked as Da Da.

Caution:

On many building sites, power circuits may be cut off in an uncontrolled and repetitive basis during construction. As a result, any Exit & Emergency Units, on these circuits, will have their batteries discharged or "cycled". The Li-ion battery in the Exit & Emergency Unit has been selected to give excellent long life performance in a controlled IEC 60598-2-22 testing environment. Excessive battery cycling will reduce through-life performance and may lead to premature battery failure. Battery warranty claims, as a result of such abuse, are specifically EXCLUDED from Clevertronics warranty terms.

Argonaut PLUS Weatherproof Emergency LED Batten Installation & Maintenance Instruction Leaflet



3000K 4000K 5700K

NOTE: Standard product codes with this symbol  are enabled with Clevertest Plus capability. Please refer to the operation guide supplied with the product for details.

Australia (Head Office)
Website: www.clevertronics.com.au
Email: info@clevertronics.com.au
Phone: +61 3 9559 2700

UK OFFICE
Website: www.clevertronics.co.uk
Email: sales@clevertronics.co.uk
Phone: 01895 430 255



Models:

ARGOPLUS-600-xx-L10POD-zz

Testing:

Manual Test zz = Blank
Zoneworks zz = ZW
Zoneworks HIVE zz = HVG
DALI-2 zz = D2

Options:

Microwave Sensor (HI/LO) xx = SEN
DALI Driver xx = DD

Spare Parts:

8002751	Replacement LED Board
1330086	Replacement 240V Driver
1330087	Replacement 240V Driver (SEN only)
1330038	Replacement 240V Driver (DD only)
1533050	Replacement Battery
LLIFE-PRO-CKIT-2PTS	Replacement Emergency Driver

Important:

It is illegal for anyone, except for a licensed electrician to install or maintain this product. Before installation, ensure that the electricity supply has been switched off and isolated. Installation must be carried out in accordance with the relevant British Standards.

Note:

This luminaire (with reinforced insulation between control/LED terminal and AC supply) contains non-user replaceable light source and battery - to be replaced (if required, refer installation instructions for battery replacement) by Clevertronics service personnel/agents or a registered electrician.

Installation:

The product can be mounted/suspended from any solid surface. Follow the below installation steps:

- Determine the installation and power entry method.
- Undo the Diffuser Clips, remove the Diffuser and Gear Tray. Position the batten base in the desired location and Mark out the fixing points on the mounting surface.
- If the cable entry is to be via the rear of the body – Drill out a suitable entry-hole in the rear of the batten body (must be suitably sealed after cable entry using a sealant). If the cable entry is via the end of the batten - Install the provided cable gland, or bring in conduit, to the base as required for the intended power access.
Note: Only round cables are to be used with the cable gland for an IP65 seal. Keep cable entry straight and tension free. Ensure all seals are tight. min. wire diameter 7mm, max. 12mm.

- **For surface mounting** -, there are 3 extrusions/posts at each end of the base. Drill out the desired number of fixing points at each end. **Fixings must only be through the extrusions/mounting posts.**

- Position the fitting to the mounting surface and mark the mounting holes.
- Cable/Gland entry to be down if mounting vertically.
- Drill the mounting holes.
- Fix the base to the surface with appropriate fixings.
- Seal any penetrations/fixing points with appropriate sealant.

- **For Surface Mount Clip mounting**, measure/mark spacing (see Dimensions image), install stainless steel clips to surface (use appropriate fixings), then snap batten into clips.

- **For Suspension Mounting**, measure/mark spacing (see Dimensions image), install suspension device, E.G chain, and connect chain to batten base.

- Wire mains power cable, 240V 50Hz, to terminals marked Lsw (Switched Active), Lem

(Emergency/Unswitched Active), N &  (and DALI Cables to terminals Da Da as applicable).

- Set Colour Switch to the desired colour (3000K / 4000K / 5700K, 4000K set as default).
- Attach Gear Tray to lanyards.
- Re-Install the Diffuser, close all the Diffuser Clips and secure with screws.
- The luminaire should be positioned so that prolonged staring into the luminaire at a distance closer than 330mm is not expected.

Wiring:

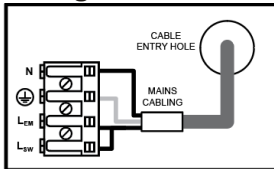

Figure A

Permanently on, 24hr operation. The switched active (L_{sw}) and un-switched active (L_{em}) connections are bridged ensuring the battery charger and general lighting LED driver is permanently energised.

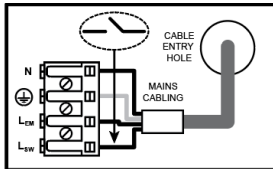

Figure B

Switched operation of the general lighting LED driver. The switched active (L_{sw}) is wired separately via a switch to provide on/off control of the general lighting. The un-switched active (L_{em}) supplying battery charger is permanently energised.*

*The switched and un-switched active should originate from the same circuit breaker or RCD.

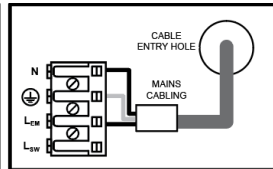
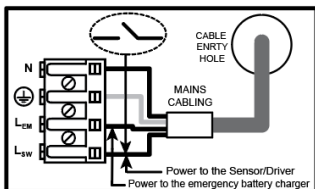

Figure C

Non-maintained operation. The switched active (L_{sw}) is not connected and the general lighting LED driver will be off (permanently). The un-switched active (L_{em}) supplying battery charger is permanently energised.

Sensor Version:



Dimensions:

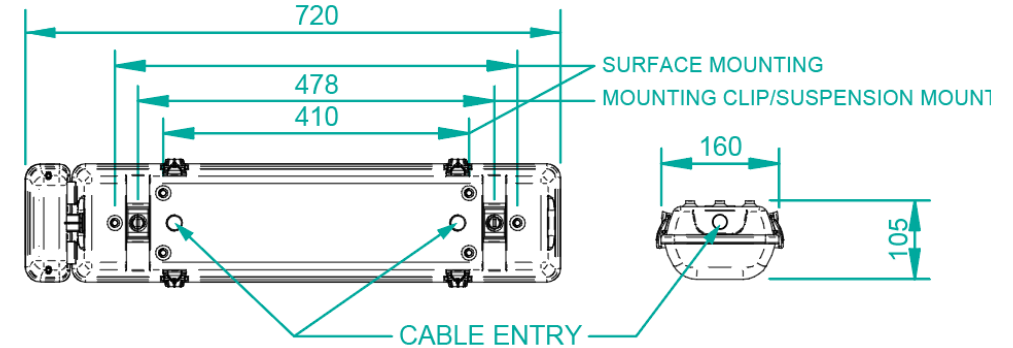

Colour Setting:

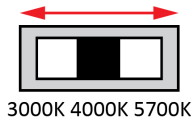

Testing Procedure:

When the unit is connected to the un-switched active, it must be allowed to charge the battery for at least 24 hours. The emergency lamp only illuminates during a power fail. Conduct the following tests:

- The emergency lamp must illuminate for at least 180 min after disconnection from the mains. If the unit fails to illuminate for the requisite time, remedial action must be taken to repair the situation and once completed, the unit must pass a subsequent test.
- Press and hold Test Button or switch Off Mains Supply, check that the emergency lamp is On.
- Release the Test Button or Switch On Mains Supply, check that the emergency lamp is Off (Non-maintained operation).

Trouble Shooting:

Below are a list of common problems and their possible causes.

Fault: The Green LED Test Switch indicator is not illuminated.

Check: A.C. is connected and is turned on.
Battery is connected
Test Switch for damage.

Fault: Lamp does not illuminate in emergency mode.

Check: A.C. is connected.
Lamp is correctly inserted.
Battery is connected

Fault: Lamp illuminates in emergency mode, but only stays on for a short period.

Check: Battery has been allowed to charge for at least 24 hours.
Battery for damage.

Warranty:

For Product Warranty information and Terms and Conditions of Sales please refer to our website <https://clevertronics.co.uk/product-warranty-statement/>